

ORJENTACIONE VISINE PRILIKOM MONTAŽE:
(sve mere prekontrolisati pre montaže)

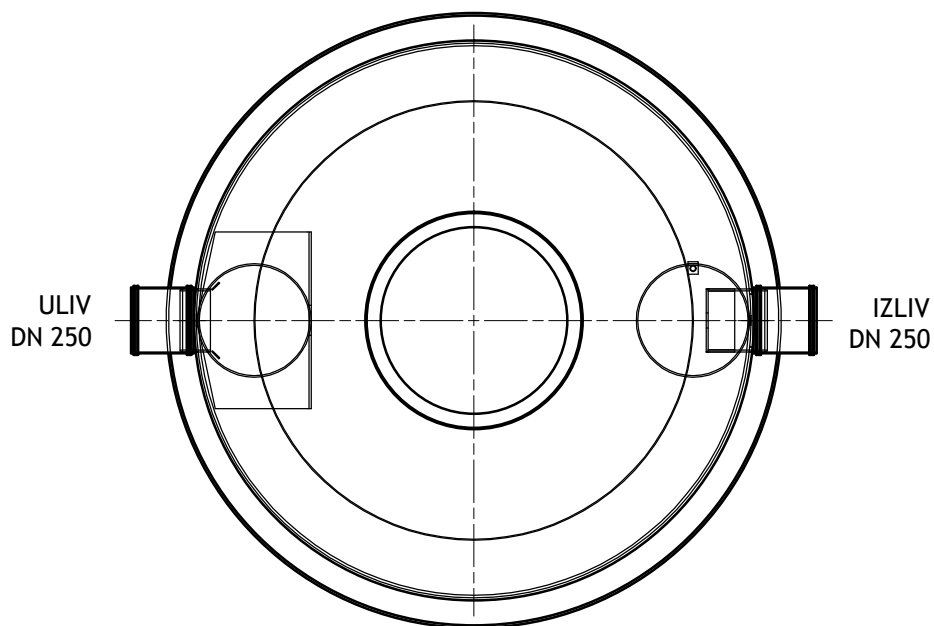
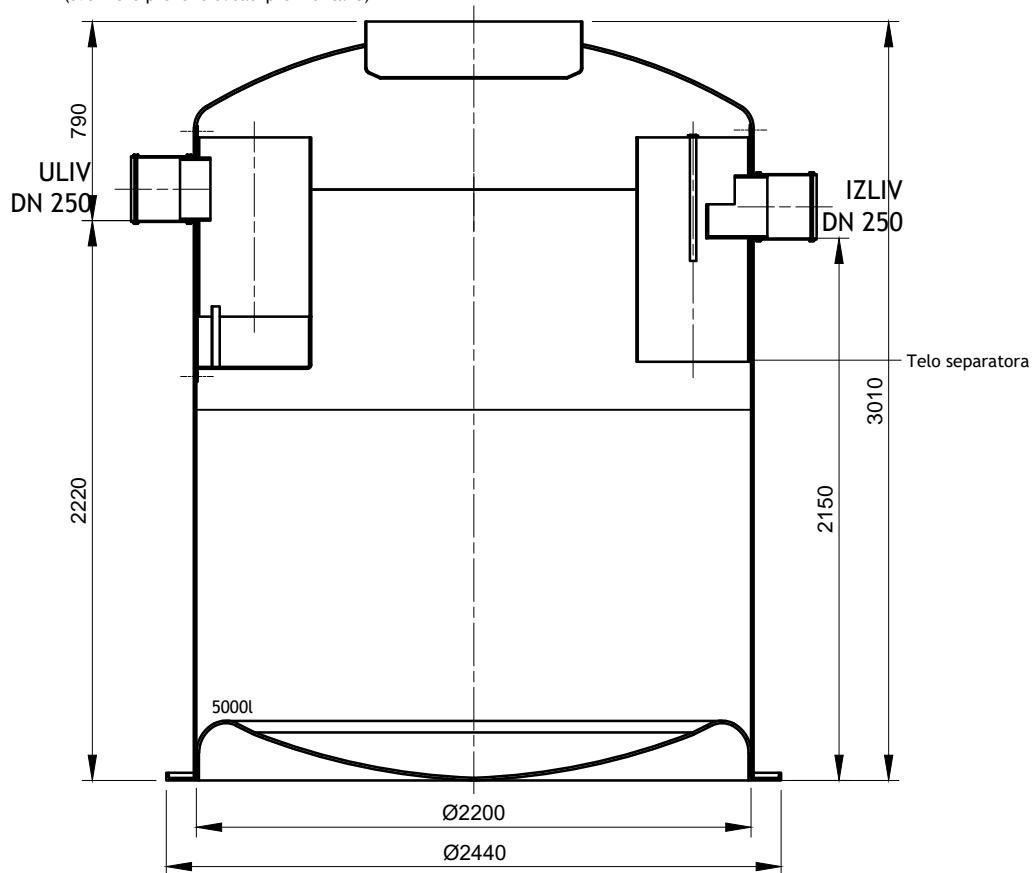

ACO Građevinski elementi d.o.o.

Mala pruga 39a
11283 Beograd
www.aco.rs

tel: +381(0)4141580
fax: +381(0)4141590
e-mail: aco@aco.rs

šifra artikla:

12514.01

razmera:

R 1:30

NAZIV:

ACO LIPUMAX G-FST NS25/5000