



When advanced water  
treatment is required

ACO Stormwater

Management

ACO Stormclean

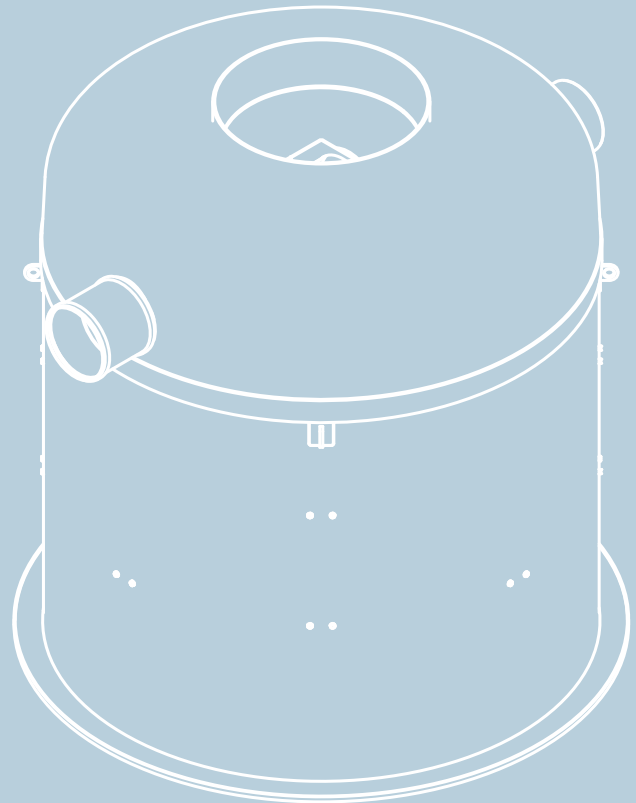
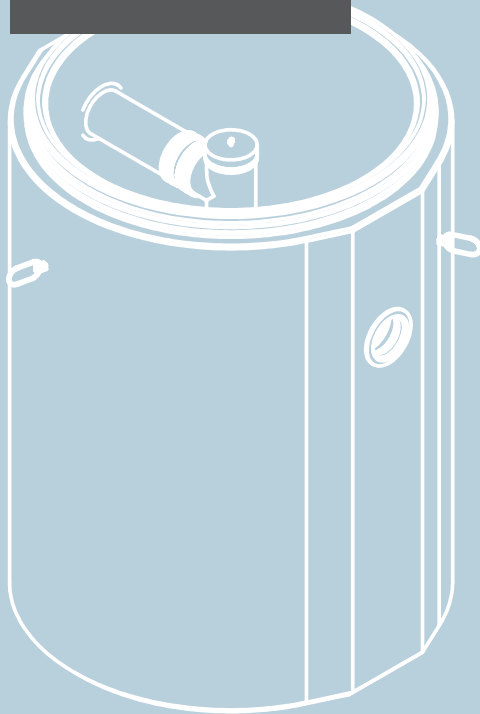

# When advanced water treatment

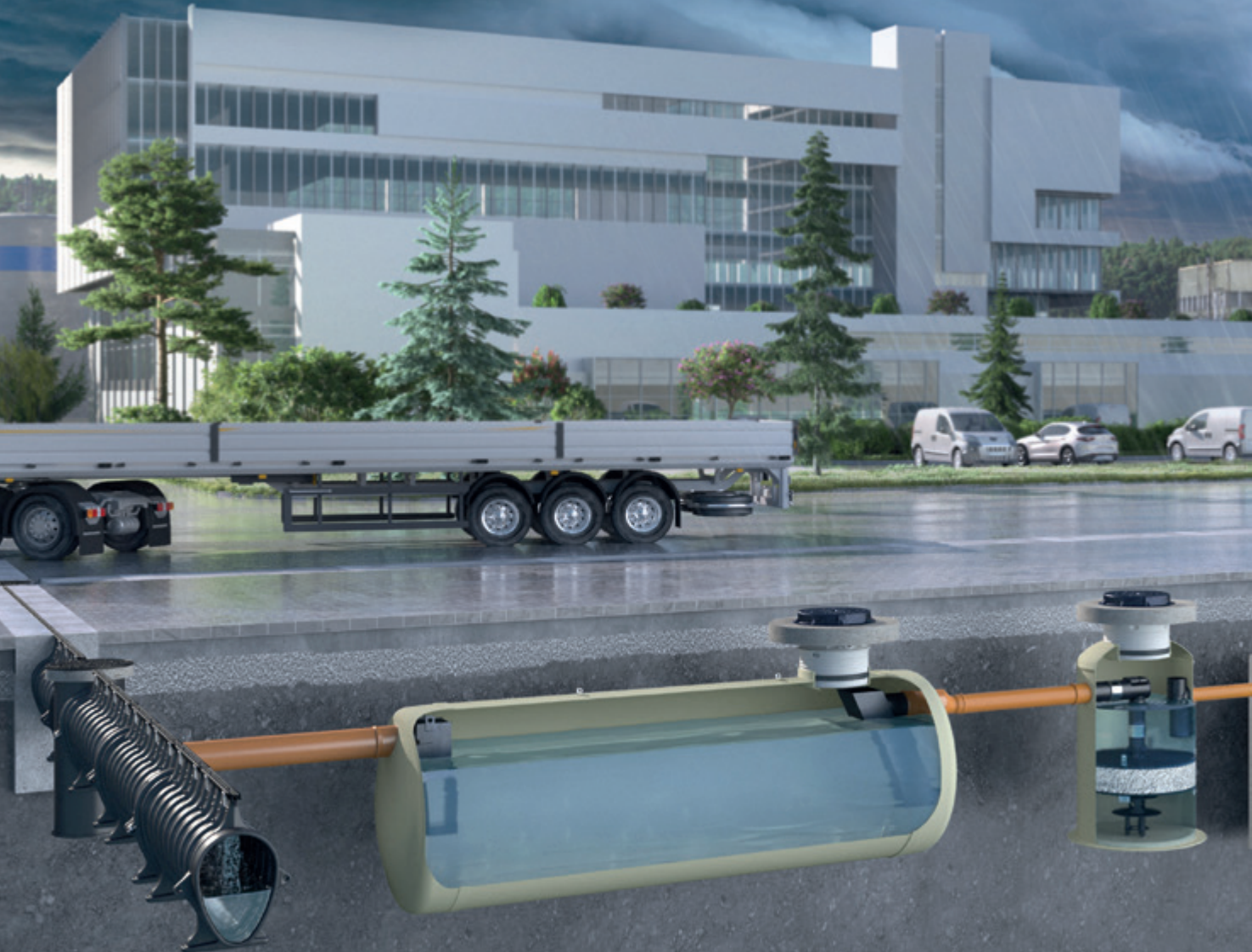

# is required

## ACO Stormwater

## Management

### ACO Stormclean

There are areas where the concentration of harmful dissolved pollutants exceed allowed limits, and the installation of a sedimentation device is not enough for effective treatment. These areas are mainly industrial areas and areas with heavy traffic loads. Examples include industrial zones, logistics centers, train or bus stations, parking lots at commercial buildings, or busy road and highway infrastructures.

When stormwater carries high concentrations of harmful dissolved pollutants, it is essential to remove those pollutant with an advanced treatment step before discharging, as untreated stormwater poses a threat to local water sources.

ACO presents the **ACO Stormclean stormwater filter** as a compact solution to advanced stormwater treatment needs. Due to its small footprint, it is an attractive alternative to large above ground soil filters when space is at a premium. ACO Stormclean combines four crucial processes – sedimentation, filtration, adsorption and precipitation – to ensure bound and dissolved pollutant are removed from stormwater.

**CLEAN:**  
pretreat and process



# Product Overview

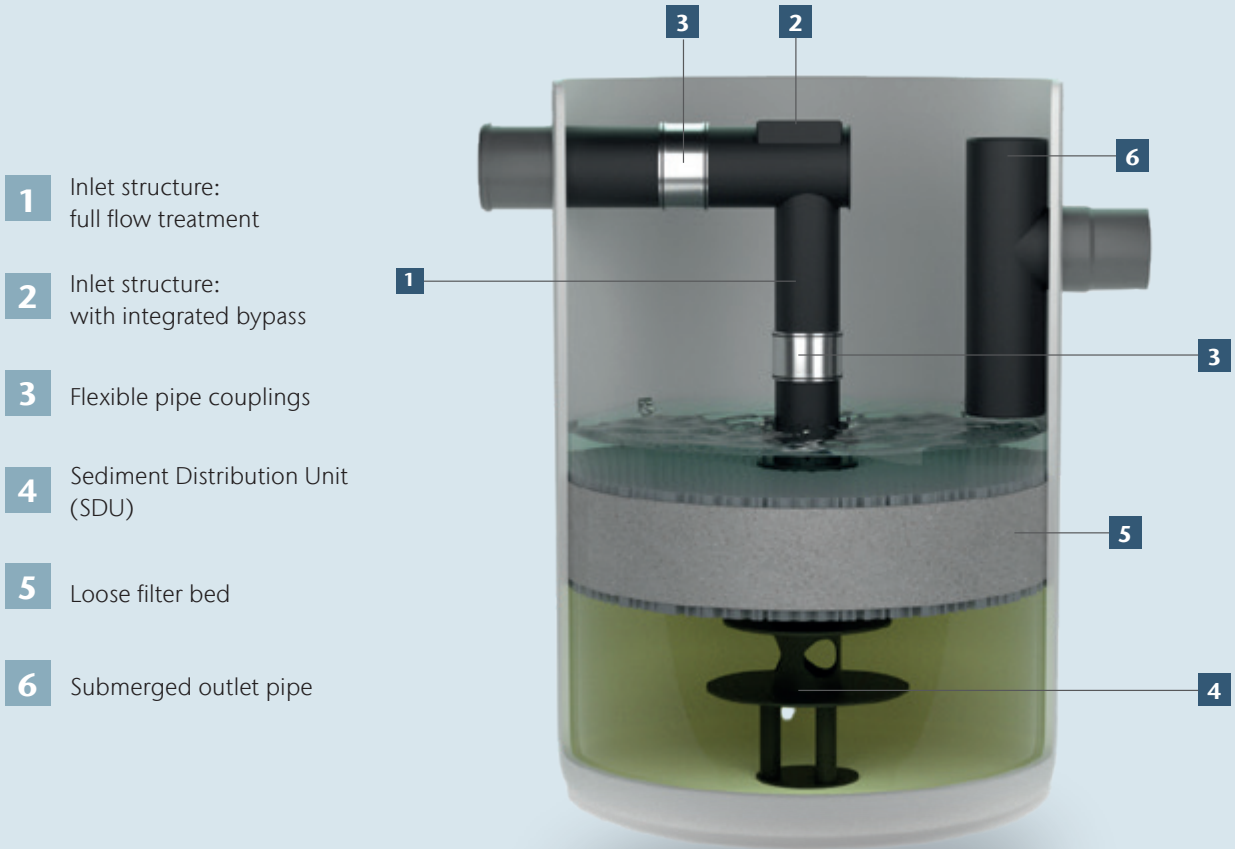

- 1 Inlet structure: full flow treatment
- 2 Inlet structure: with integrated bypass
- 3 Flexible pipe couplings
- 4 Sediment Distribution Unit (SDU)
- 5 Loose filter bed
- 6 Submerged outlet pipe

The **ACO system chain** creates drainage solutions for the environmental conditions of tomorrow.



The **ACO Stormclean** is an essential product, which helps to achieve desired water quality.

# ACO Filter Media Storm

At the core of ACO Stormclean is ACO Filter Media Storm, a stormwater filter material developed with the EU WFD (Water Framework Directive) at its heart to meet national certification schemes.

A carefully engineered mixture of granule sizes allows the filter to remove small particle sizes without clogging. In addition, the choice of special granules capable of adsorbing key pollutants such as Zinc (Zn), Lead (Pb), Copper (Cu) and oil ensure dissolved pollutants are removed and retained by the filter. ACO Filter Material is suitable for use as a decentralised rainwater filter protecting surface waters and treatment before ground water infiltration, protecting precious ground water sources.

## ACO Filter Media Storm

is a granular reactive filtration material for use in stormwater quality improvement. Key applications are as an enhancement to sedimentation solutions to remove dissolved pollutants, as a standalone improvement device prior to groundwater infiltration (in conjunction with geocellular storage such as ACO Stormbrixx) or as an integral component of an infiltration shaft/trench.

## Benefits

- Light weight (0,7 kg/l) for ease of transport
- Filtration of suspended solids
- Sorption of dissolved pollutants
- Efficient cleaning for high surface areas
- Resistant to de-icing salts
- Sustainable: partially made from waste materials
- Low cost
- To prolong filter lifetime, we recommend being located after ACO sedimentation solutions



For more information about  
ACO Stormwater Management  
see the full-video animation



# Treatment process

Heavily polluted stormwater flows into the ACO Stormclean stormwater filter.

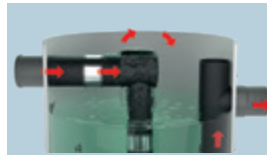
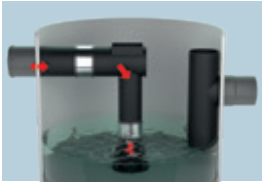

A large part of the oil separates in the central pipe.

Then, larger particles like sand and gravel settle at the bottom, which prolongs the lifetime of the media.

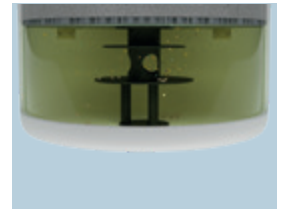
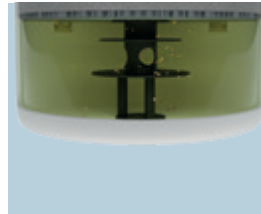

The patented design prevents the captured sediment from being flushed out and ensures the even distribution of water in the sedimentation section.

The suspended solids are captured and retained in the filter media. Dissolved pollutants are adsorbed. At the same time pH is neutralized.

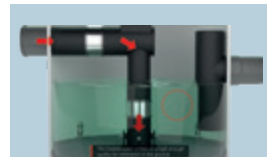
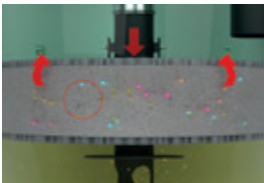

The treated water is then of a high enough quality for infiltration in the ground.

High flows during heavy storms activate the integrated overflow.

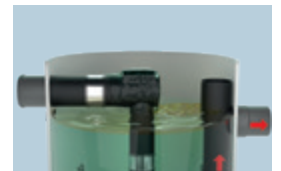
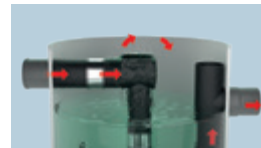

The design of the outlet allows the retention of the captured floatables.

For more information about  
ACO Stormclean treatment process  
see the full-video animation



# ACO Stormclean

All parts of the ACO Stormclean are easily accessible from the surface allowing simplified maintenance.

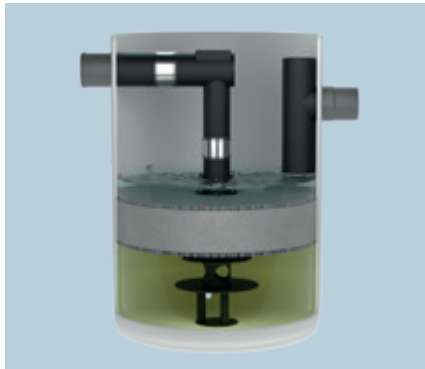
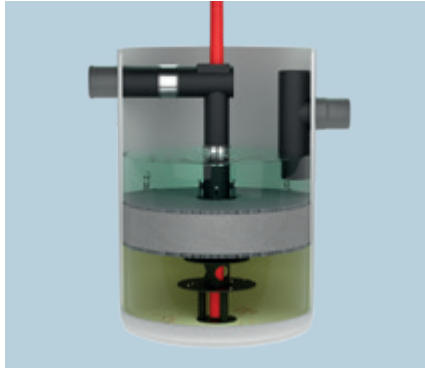

Regular maintenance ensures the long service life of the filter medium, which can be easily replaced if necessary.

## Benefits

- Official **third party tested** removal efficiencies for TSS, heavy metals and hydrocarbons
- Compact design with **small footprint**
- **Easy maintenance and service**
  - Quick access to sump
  - Loose filter bed
  - All parts can be demounted
- **Scalable** with many shafts sizes / connectable areas available
- Only **25 cm pressure drop** (level difference inlet to outlet) allowing flat installations
- **ACO Filter Media Storm** or **Storm+** available

## ACO Stormclean applications:

All applications where advanced stormwater treatment is required with ACO Filter Media Storm and Storm+. An alternative to soil filters.

- Stormwater treatment with a focus on TSS and heavy metals; also hydrocarbon removal
- Strict stipulations / high removal efficiency is necessary
- Possible discharge to sensitive surface waters and ground water infiltration
- Small footprint required for decentralized stormwater treatment

ACO Stormclean G



ACO Stormclean G

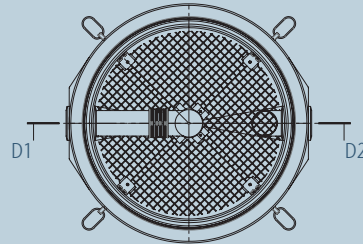
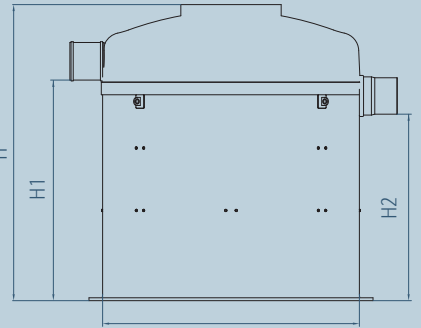
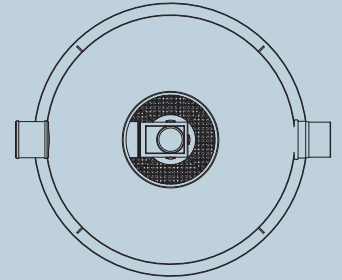
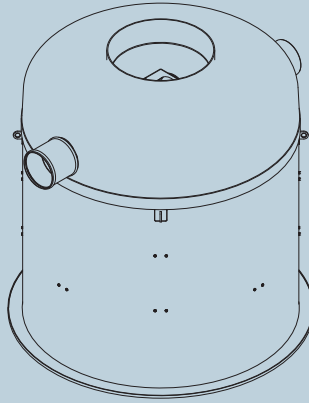

ACO Stormclean C

ACO Stormclean C

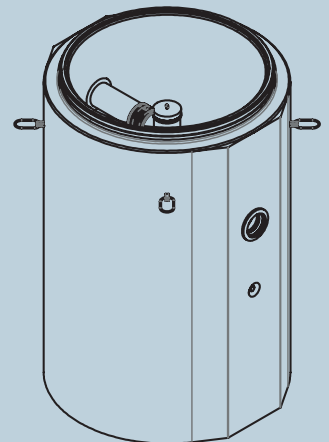
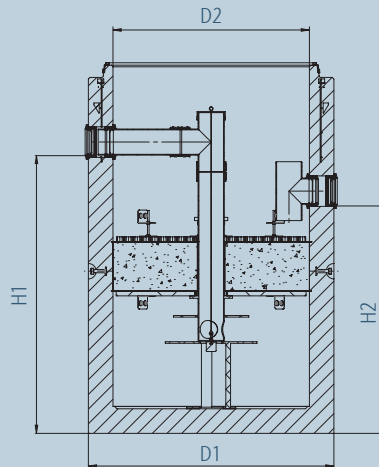



## ACO Stormclean G

Chamber diameter	Runoff area*	Max. tested filter media flow rate	Max. bypass flow rate	Filter media surface area	Filter media volume	Man-hole cover size	Pipe con.	Wgt.	Total vol.	Max. oil stor. cap.	Max. sediment stor. cap.	H	D1	D2	H1	H2	T-tank	Item No.
[mm]	[mm <sup>2</sup> ]	[l/s]	[l/s]	[m <sup>2</sup> ]	[m <sup>3</sup> ]	[DN]	[DN]	[kg]	[l]	[l]	[l]	[mm]	[mm]	[mm]	[mm]	[mm]	[mm]	

### ACO Filter Media Storm (DIBt tested for TSS and oil only)

1000	500	5	24	0,77	0,23	1x600	200	314	966	80	286	2100	1000	1240	1565	1265	535	12968.MB1
1200	885	9	24	1,11	0,33	1x600	200	450	1405	117	409	2125	1200	1400	1580	1280	545	12969.MB1
1500	1385	14	45	1,74	0,52	1x600	250	667	2553	434	653	2580	1500	1720	1775	1475	805	12970.MB1
1800	1900	19	75	2,51	0,75	1x600	300	985	3646	478	941	2475	1800	2040	1763	1463	712	12971.MB1
2200	3000	30	75	3,75	1,13	1x600	300	1544	5585	1201	974	2560	2200	2440	1913	1613	647	12972.MB1

### ACO Filter Media Storm + (DIBt tested for TSS, oil and heavy metals)

1000	500	5	24	0,77	0,23	1x600	200	314	966	80	286	2100	1000	1240	1565	1265	535	12968.MB2
1200	885	9	24	1,11	0,33	1x600	200	450	1405	117	409	2125	1200	1400	1580	1280	545	12969.MB2
1500	1385	14	45	1,74	0,52	1x600	250	667	2553	434	653	2580	1500	1720	1775	1475	805	12970.MB2
1800	1900	19	75	2,51	0,75	1x600	300	985	3646	478	941	2475	1800	2040	1763	1463	712	12971.MB1
2200	3000	30	75	3,75	1,13	1x600	300	1544	5585	1201	974	2560	2200	2440	1913	1613	647	12972.MB1

## ACO Stormclean C

Chmbr. diam.	Runoff area*	Max. tested filter media flow rate	Max. bypass flow rate	Filter media surface area	Filter media volume	Man-hole cover size	Pipe con.	Wgt.	Total vol.	Max. oil stor. cap.	Max. sediment stor. cap.	H	D1	D2	H1	H2	T-tank	Item No. TSS & Oil	Item No. TSS, Oil & HM
[mm]	[mm <sup>2</sup> ]	[l/s]	[l/s]	[m <sup>2</sup> ]	[m <sup>3</sup> ]	[mm]	[DN]	[kg]	[l]	[l]	[l]	[mm]	[mm]	[mm]	[mm]	[mm]	[mm]		
1000	500	5	24	0,77	0,23	600	200	3465	986	75	306	2250	1300	1000	1705	1405	545	3010601	3010606
1200	885	9	24	1,11	0,33	600	200	4239	1419	109	444	2250	1500	1200	1705	1405	545	3010602	3010607
1500	1385	13	45	1,74	0,52	800	250	6398	2483	341	694	2500	1800	1500	1905	1605	595	3010603	3010608
1750	1895	19	75	2,37	0,71	800	315	7186	3379	468	950	2430	2050	1750	1905	1605	525	3010604	3010609
2200	3000	30	75	3,75	1,13	800	315	8540	5721	926	1501	2570	2450	2200	2005	1705	565	3010605	3010610

\*Runoff area according to DIBt testing flow rate 2,5-25 l/s\*ha

ACO. we care for water



Every ACO product supports  
the ACO WaterCycle



- 
- ACO stormwater management
  - ACO pumping stations
  - ACO oil separators
  - ACO grease separators
  - ACO hydrodynamic separators
  - ACO stormwater filters
  - ACO sedimentation tanks
- 

ACO građevinski elementi doo

III Industrijska zona bb  
22314 Krnješevci, Stara Pazova,  
Srbija

[www.aco.rs](http://www.aco.rs)



Edition 06/2023 – Subject to alterations