

# ACO MONOBLOCK RD200V tip 10.0

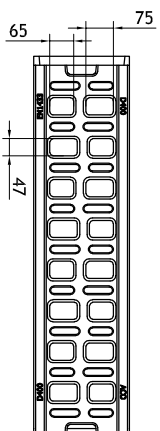

Klasa opt.	Tip	H [mm]	Art.-br.
D 400 - F 900	10.0	430	133131

ACO MONOBLOCK RD200V monolitni kanal od polimerbetona sa otvorima u obliku rešetke. Gradevinska dužina 100 cm, gradevinska širina 26 cm, svetla širina 20 cm, ukupna visina 43cm, težina 102 kg, za klasu opterećenja F900 u skladu sa SRB EN 1433.

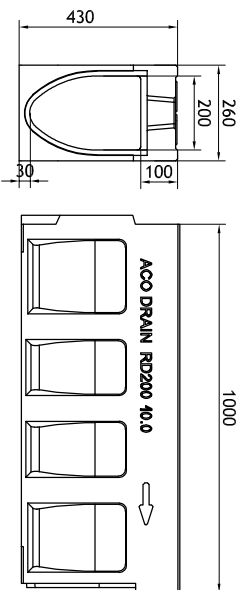
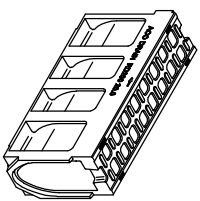
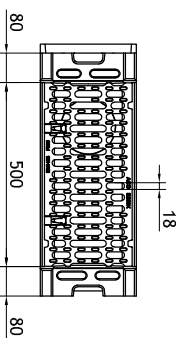
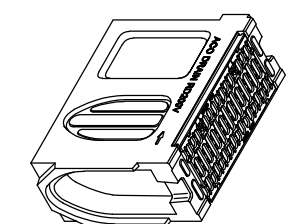
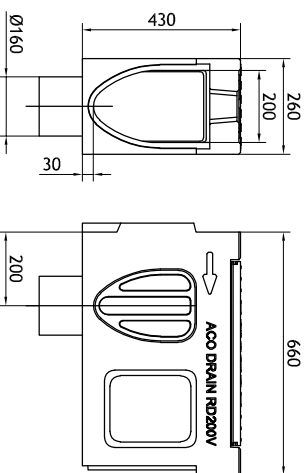

Revizija	H [mm]	Art.-br.
Tip 10.1	430	natural 133164

Revizija	H [mm]	Art.-br.
Tip 10.2	430	natural 133165

ACO MONOBLOCK RD200V revizija sa liveno gvozdenom rešetkom

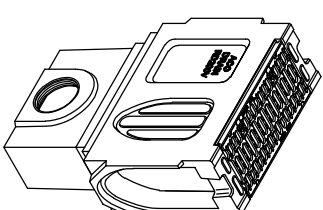
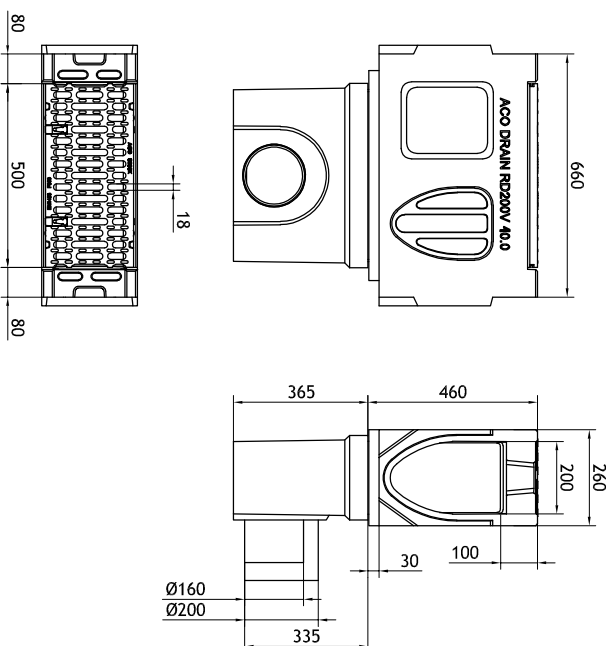

Sabirno okno	Tip	H [mm]	Art.-br.
gornji deo	10.0	460	133166
donji deo	Ø160	365	10935
donji deo	Ø200	365	10936
korpa	-	-	13999

ACO MONOBLOCK RD200V sabirno okno sa liveno gvozdenom rešetkom

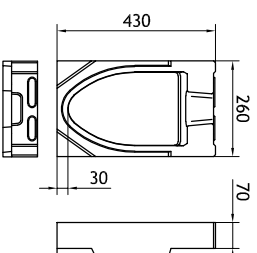

Tip	H [mm]	Art.-br.
10.0	430	natural 133168

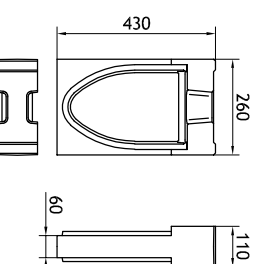
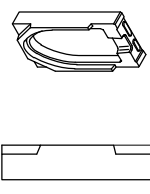

Tip	H [mm]	Art.-br.
10.0	430	natural 133167

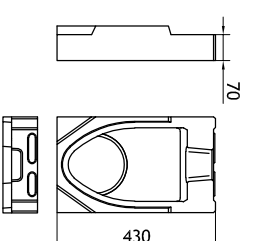
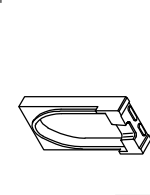

Tip	H [mm]	Art.-br.
10.0	430	133169 natural

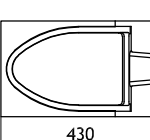

Adapter za kaskadnu vezu  
0,0-10,0 artikl 152013  
Adapter za kaskadnu vezu  
10,0-20,0 artikl 152014

Sistem linisigurno odvodjavanja:

**Monoblock RD 200V tip 10.0**

ACO Gradevinski elementi d.o.o.  
III Industrijska zona bk, bb  
22134 Vrnjinec  
www.aco.rs  
Fax: +381 22 811 590  
E-mail: aco@aco.rs

