

ACO MONOBLOCK RD150V tip 10.0

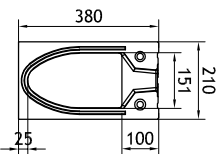

Klasa opt.	Tip	H [mm]	Art.-br.
D 400 - F 900	10.0	380	antracit 133004 natural 130074

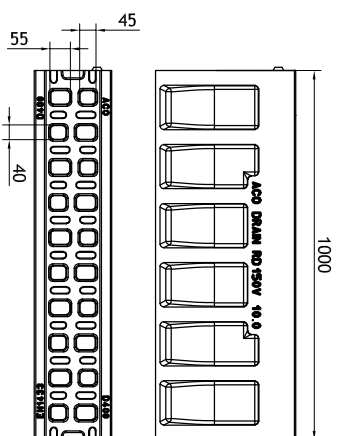

ACO MONOBLOCK RD150V monolitni kanal od polimerbetona sa otvorima u obliku rešetke. Građevinska dužina 100 cm, građevinska širina 21 cm, svetla širina 15 cm, ukupna visina 38cm, težina 74,9 kg, za klasu opterećenja F900 u skladu sa SRB EN 1433.

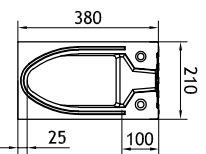

Revizija	H [mm]	Art.-br.
Tip 10.0	380	antracit 130127 natural 130077

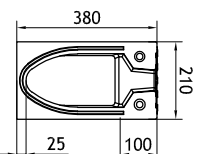
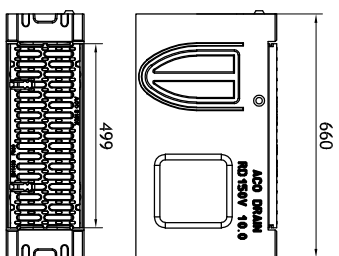

Revizija	H [mm]	Art.-br.
Tip 10.0	380	antracit 130130 natural 130080

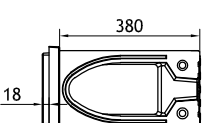
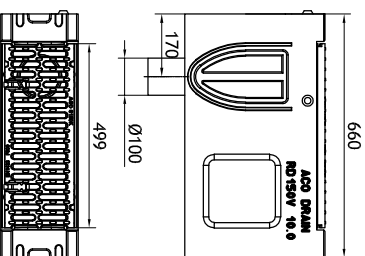

Reviziono okno	Tip	Art.-br.
gornji deo	10.0	antracit 130133 natural 130083
donji deo	Ø160	10935
	Ø200	10936

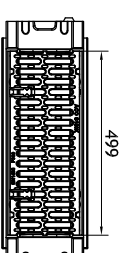
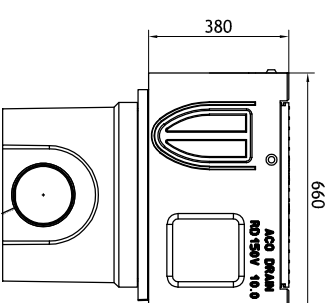
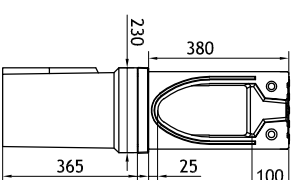

ACO MONOBLOCK RD150V sabirno okno sa liveno gvozdrenom rešetkom

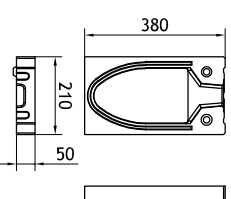

ACO MONOBLOCK RD150V tip 0.0 čeonni poklopci

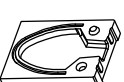

Tip	Art.-br.
antracit 10.0	130136
natural	130086

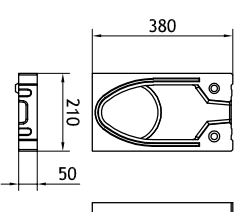

ACO MONOBLOCK RD150V tip 0.0 čeonni poklopci sa f1160

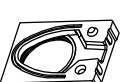

Tip	Art.-br.
antracit 10.0	130139
natural	130089

Sistem litijskog odvodnjavanja:

Monoblock RD 150V tip 10.0



ACO Građevinski elementi d.o.o.
III Industrijska zona br. 444 +381 22 814 580
22134 Koprivnica
www.aco.hr
Crtanih odvodnjavanja