

Detaili X u Y

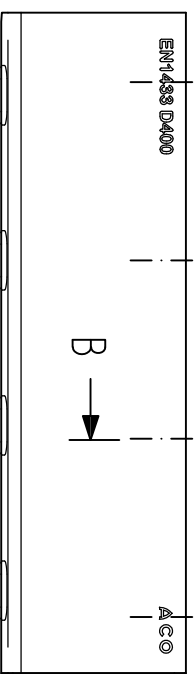

Presek B-B

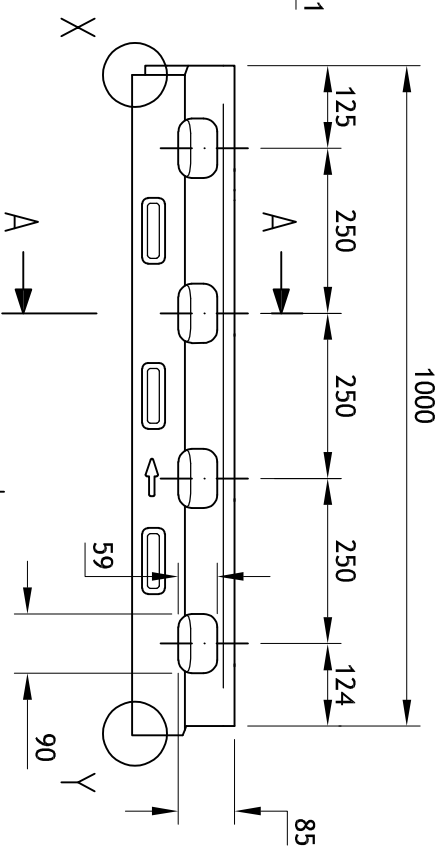
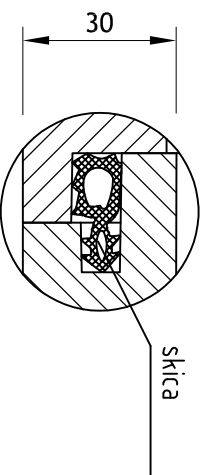
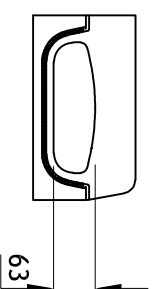
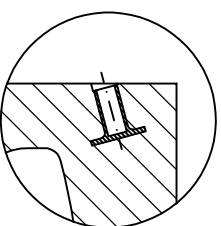

Presek A-A

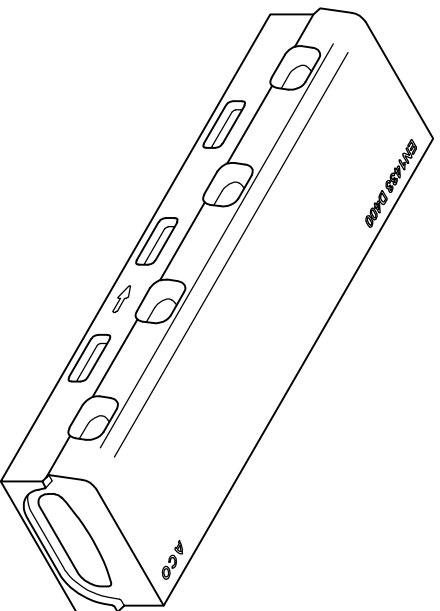
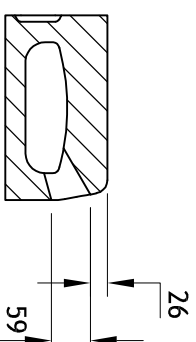

NAZIV:
ACO kerbDrain KD 200-75 polimerbetonski kanal 1m

Ovde prikazani: levi kanal
Materijal kanala: Polimerbeton
Veživni materijal: Poliesterska smola
Zapitivni materijal: EPDM