

# ACO SELF Euroline

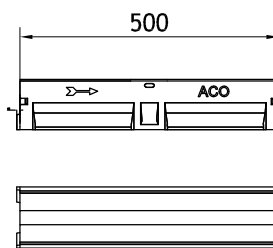

sa pocinkovanim rešetkom

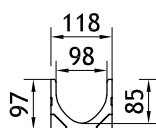
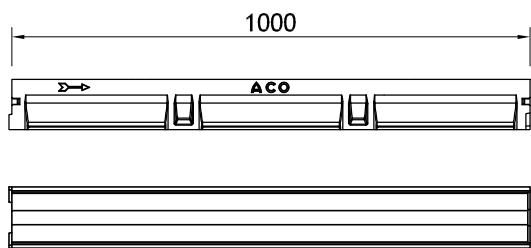
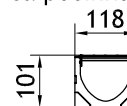

sa plastičnim rešetkom

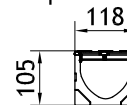

sa inox podužnom rešetkom

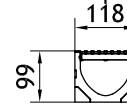

sa l.gvozdenom rešetkom

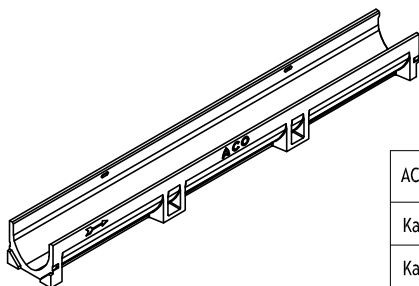
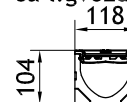

ACO Euroline	Art.br.
Kanal 1,0m	38500
Kanal 0,5m	38502

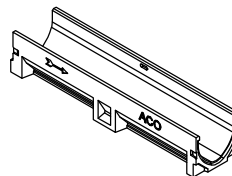

ACO SELF Euroline kanal za linijsko odvodnjavanje objekta, napravljen od polimerbetona za klasu opterećenja A15, dužine elemenata 100cm ili 50cm, u skladu sa EN 1433.

ACO SELF Euroline kanal 1m sa vertikalnim izlivom DN100

ACO SELF Euroline sabirno okno

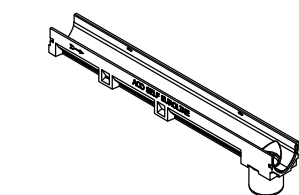
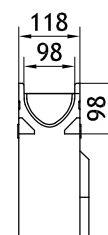
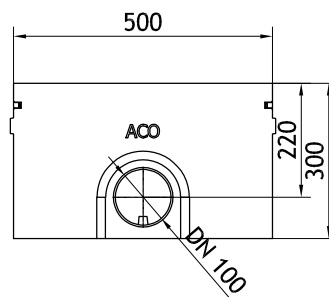
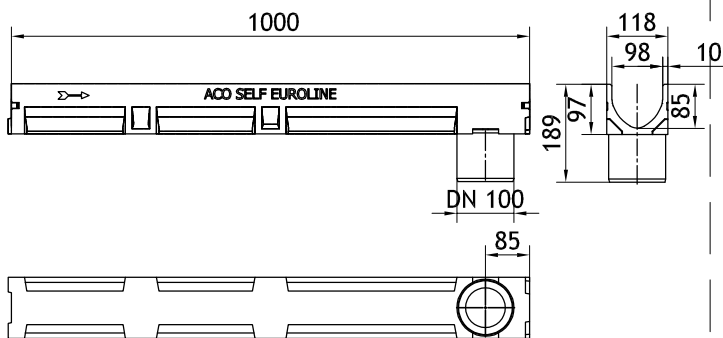

ACO Euroline	Art.br.
Kanal 1,0m sa DN100	38501

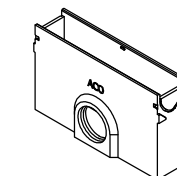

ACO Euroline	Art.br.
Saborno okno	38503

ACO SELF Euroline čeonu poklopac za zatvaranje kanala i sa horizontalni priključkom DN100

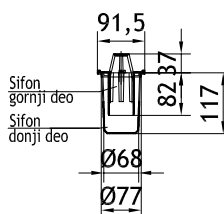
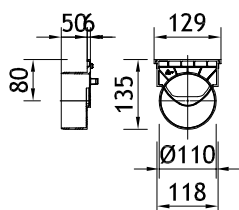
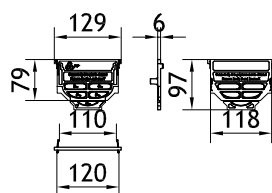

ACO Euroline	Art.br.
Čeonu poklopac	319288
Čeonu poklopac DN100	319289
Sifon za kanal	01666



Sistem linijskog odvodnjavanja:

**ACO SELF Euroline**



ACO građevinski elementi d.o.o.

III industrijska zona bb tel: +381(0)4141580  
22314 Krnješevci fax: +381(0)4141590  
www.aco.rs e-mail: aco@aco.rs